

CONOCEMOS EL TABLERO POSICIONAL

- Resuelve los siguientes ejercicios.

D	U

En el tablero posicional ubicamos las decenas y unidades.

Ejemplo.

D	U



D	U
1	3

Ahora hazlo tú.

D	U





D	U

D	U





D	U

- *Seguimos resolviendo los ejemplos, en el tablero posicional.*

D	U
	



D	U

D	U
	



D	U

D	U





D	U
1	5

D	U



D	U
1	2

D	U
	



D	U

- Cuenta las barras y cuadraditos; luego coloca en el tablero posicional según corresponda, las decenas.
- Codifica los ejercicios.

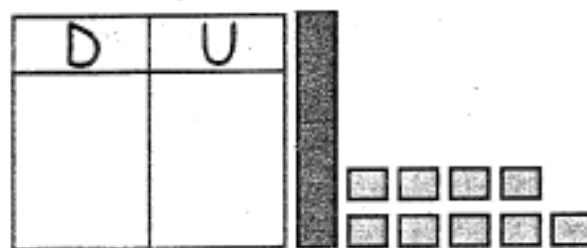
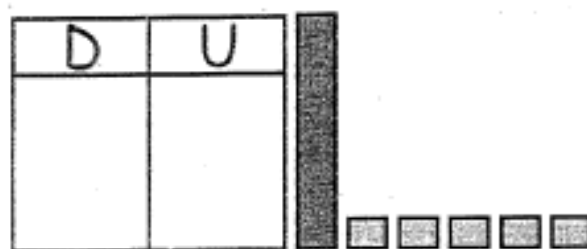
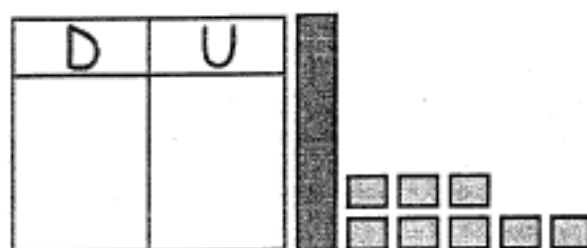
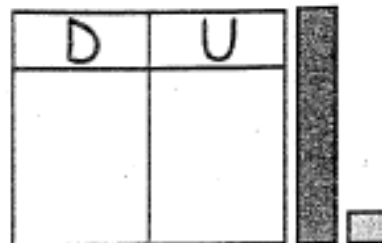
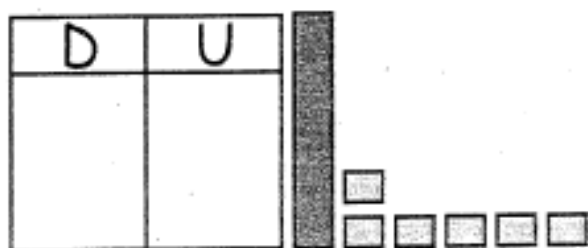
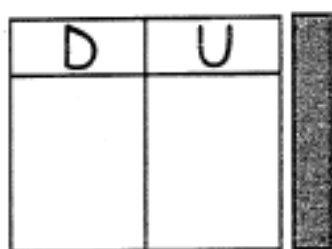
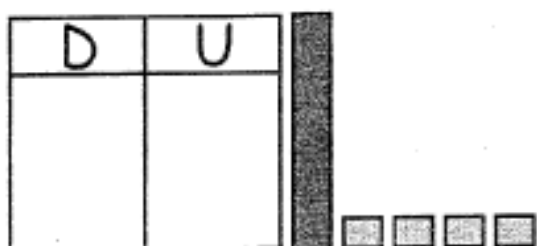
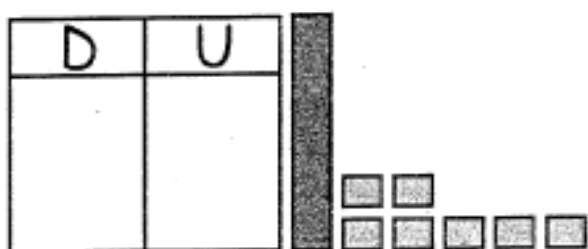
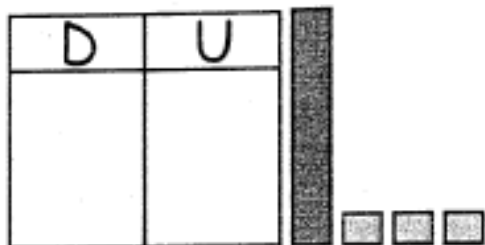

- *Marca con una x lo que es más largo, y colorea lo que es más corto.*

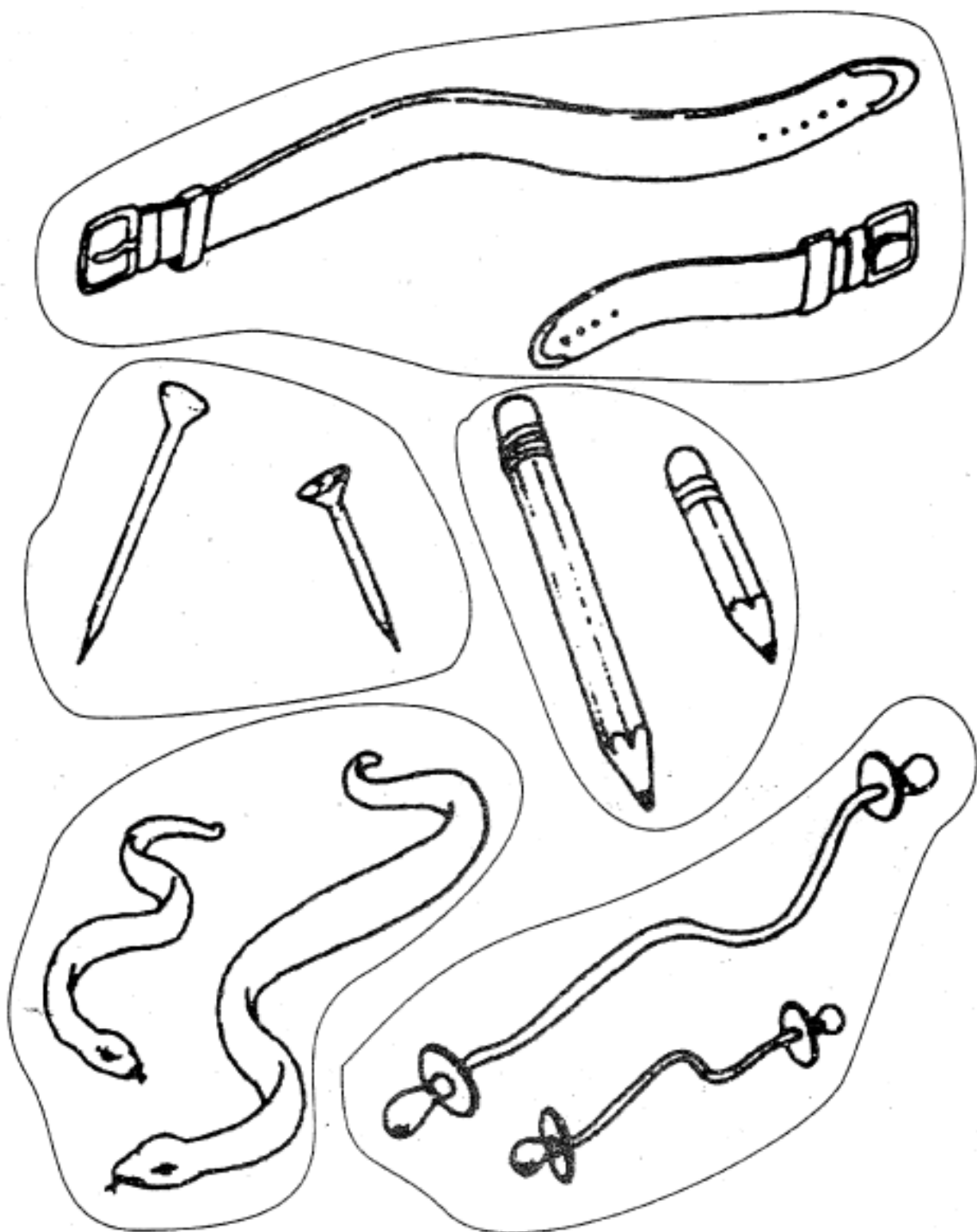

- *Pega bolitas de papel en los objetos largos.*
- *Coloca puntitos con plumones sobre los objetos cortos.*

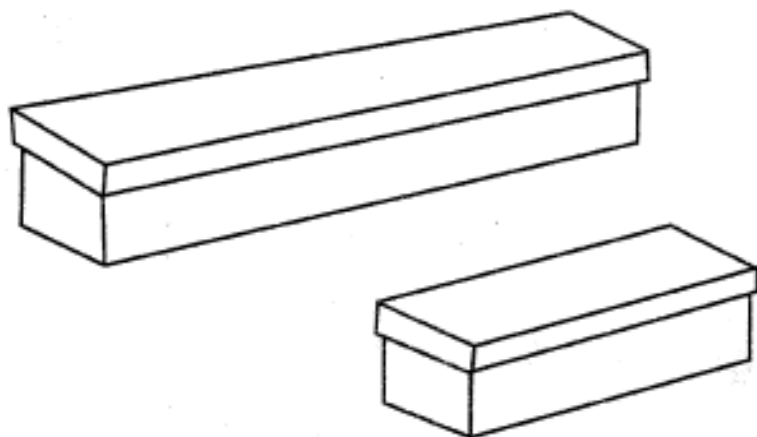

- *Colorea solo la fila de flechas que van hacia la derecha, desde la más gruesa hasta lo más delgada.*
- *Seriación de acuerdo al color*

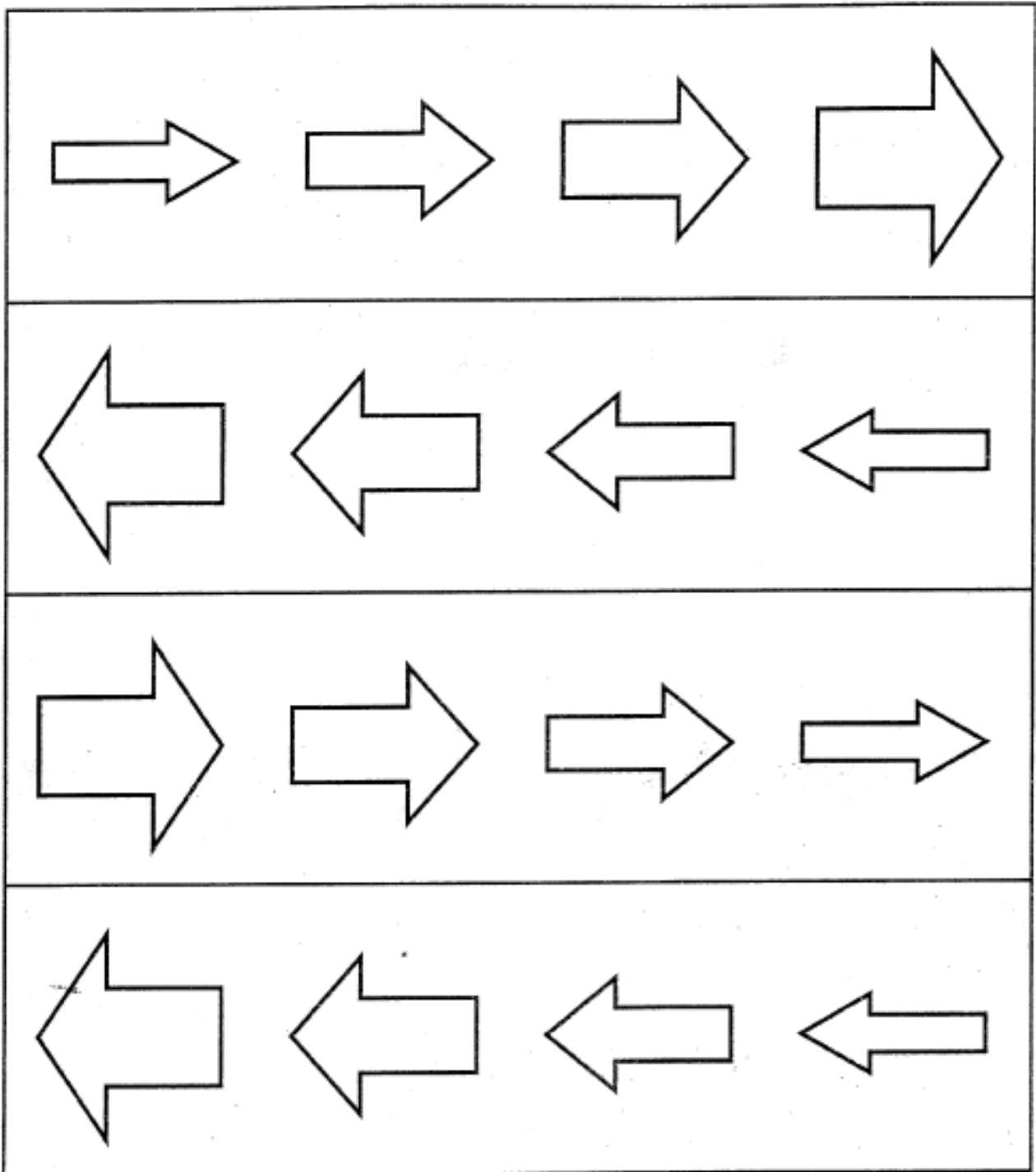

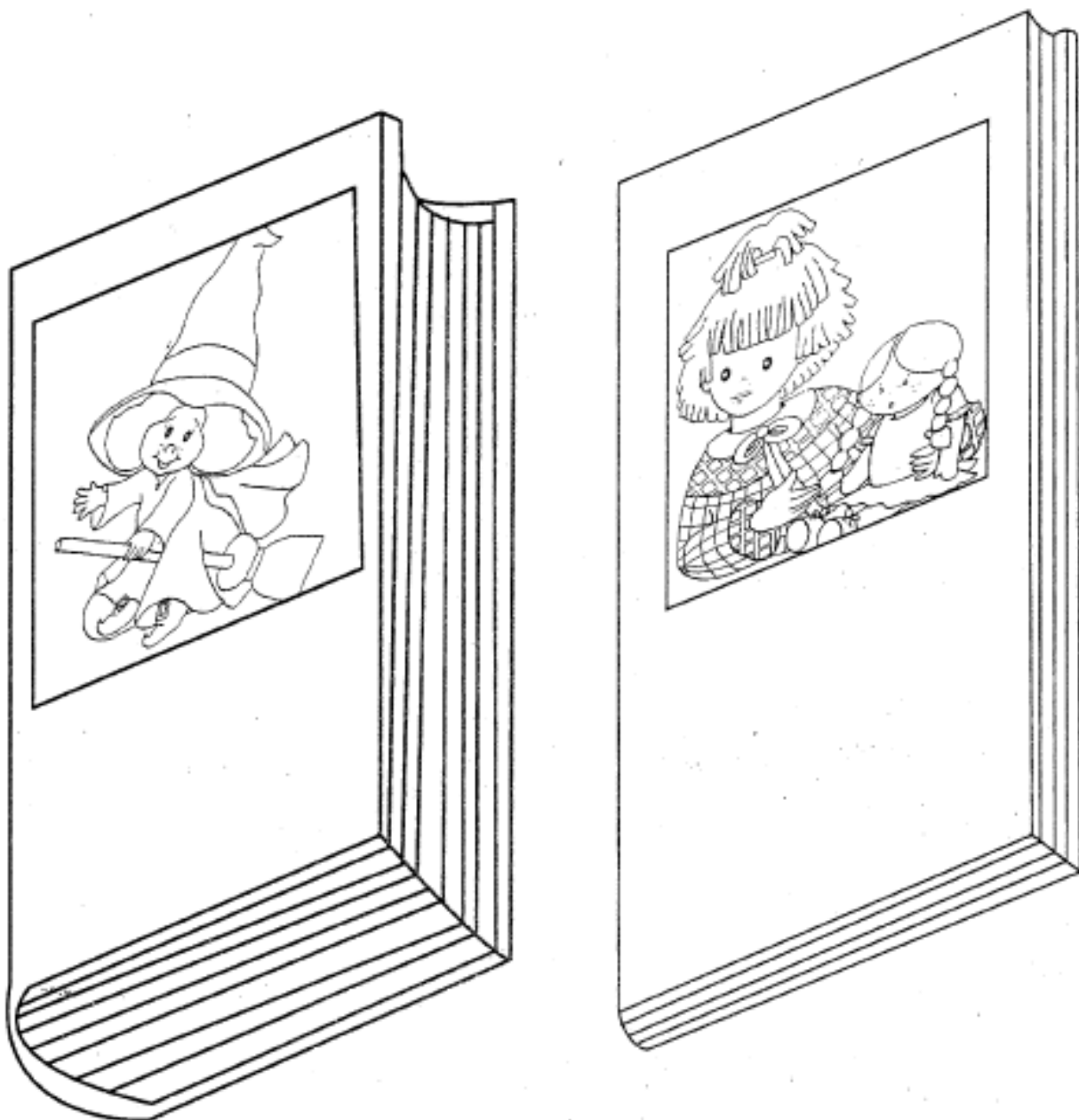

- *Rasga papel y pégalo en el libro grueso.*
- *Colorea el libro delgado.*

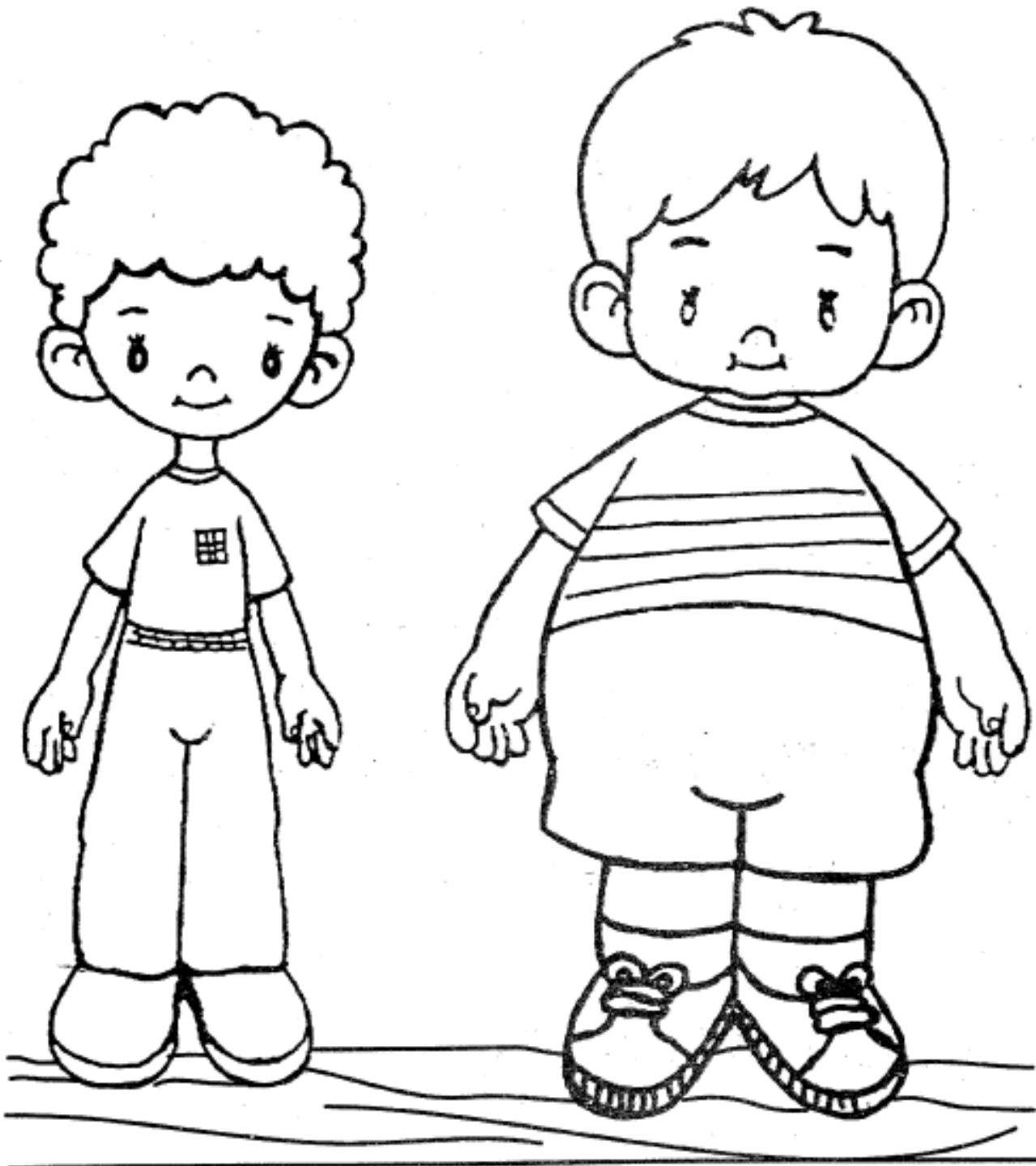

- *Colorea el niño grueso.*
- *Marca el niño delgado.*
- *Las dimensiones de grueso y delgado.*

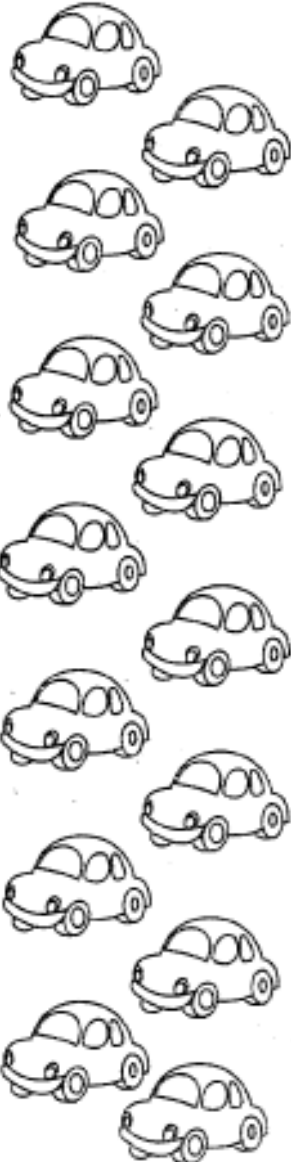
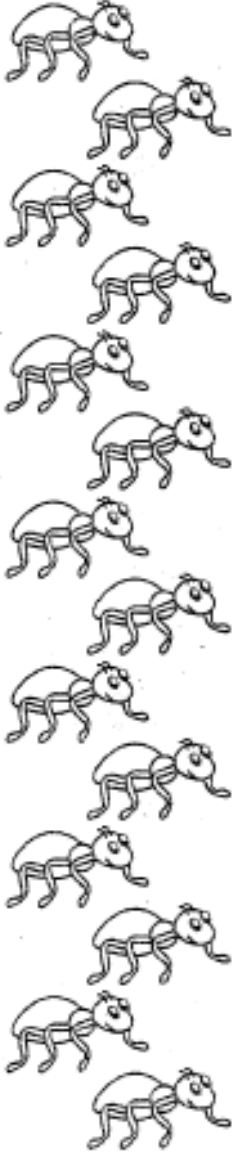

- *Colorea los dibujos según te indica los números.*

15	13	12	14
			

- *Escribe la secuencia numérica de manera creciente.*
- *Secuencia numérica creciente.*

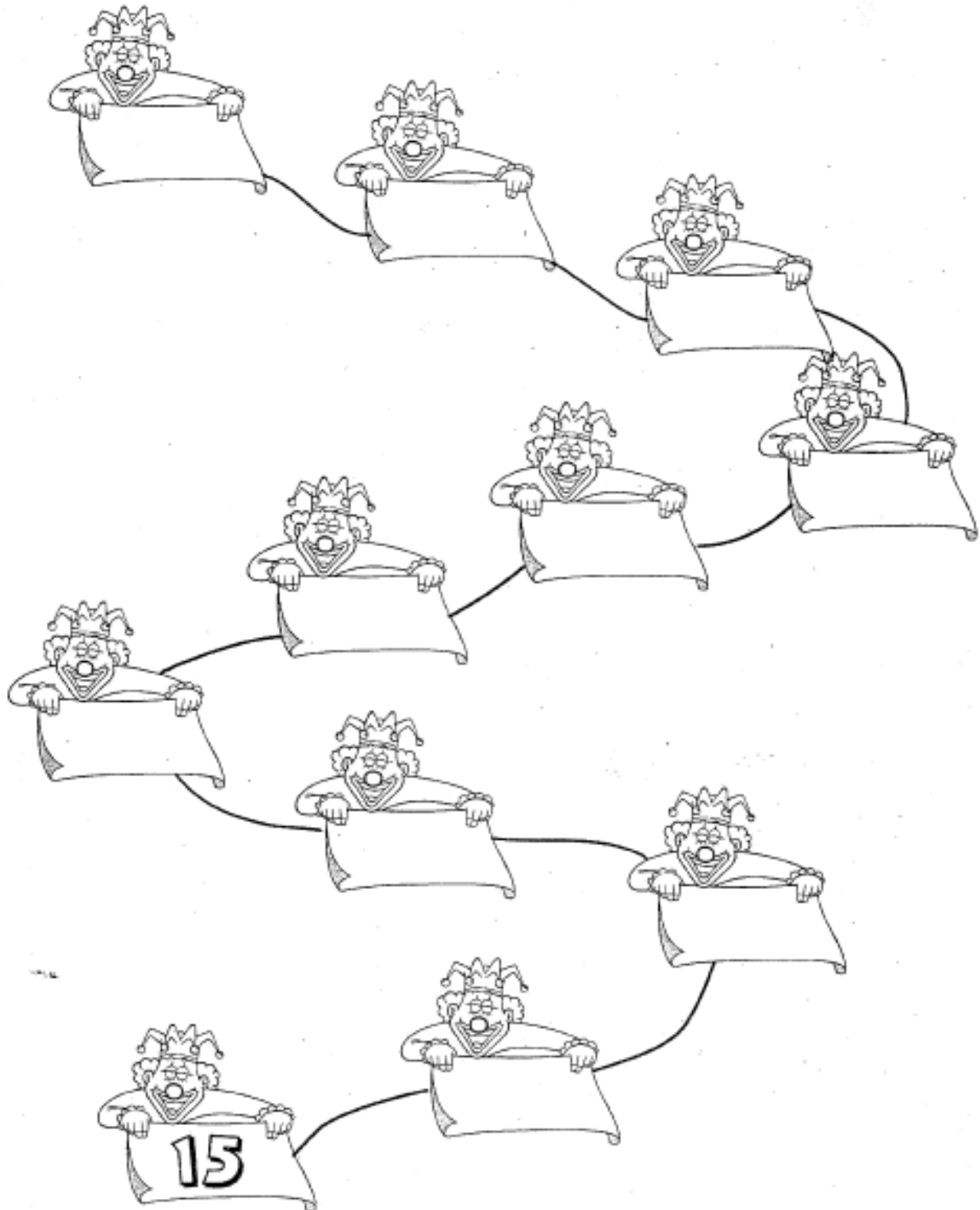

- *Colorea la jirafa más alta y encierra en un círculo a la jirafa baja.*

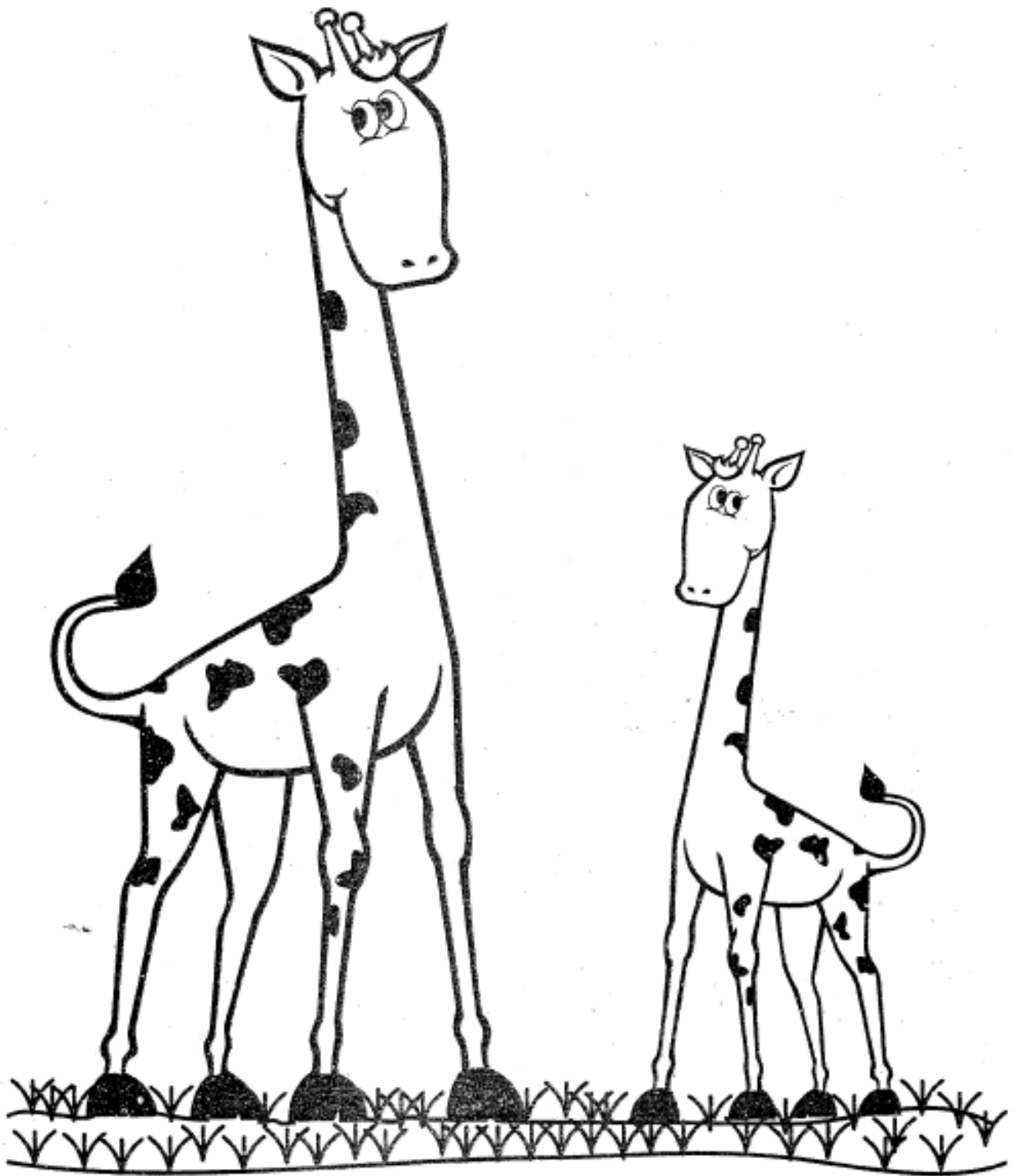

- *Encierra a la niña de estatura alta; y pinta a la niña de estatura baja.*
- *Rasga papel y pega en el edificio alto, y pinta el edificio bajo.*

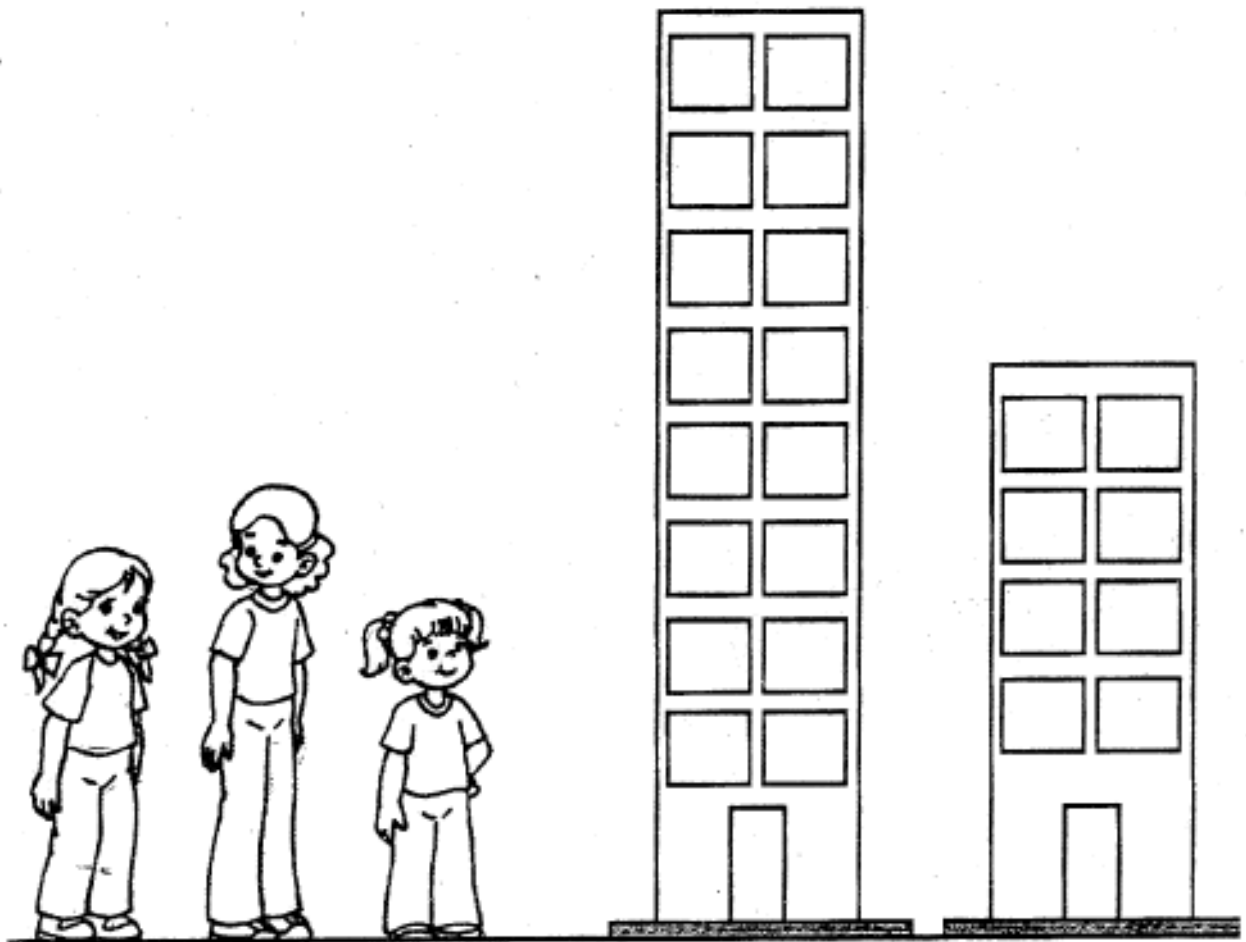

- *Pega lana picada en la palmera alta: luego, encierra en un círculo la palmera más baja.*

